

JC90

Multi Carburettor Filter Baseplates

Baseplates - JC90 (Black)

Part No	Carburettors - Engine/Manifold Fitting	Centres (mm)
JC90BB	(2x) Weber IDA3C Porsche 911	94

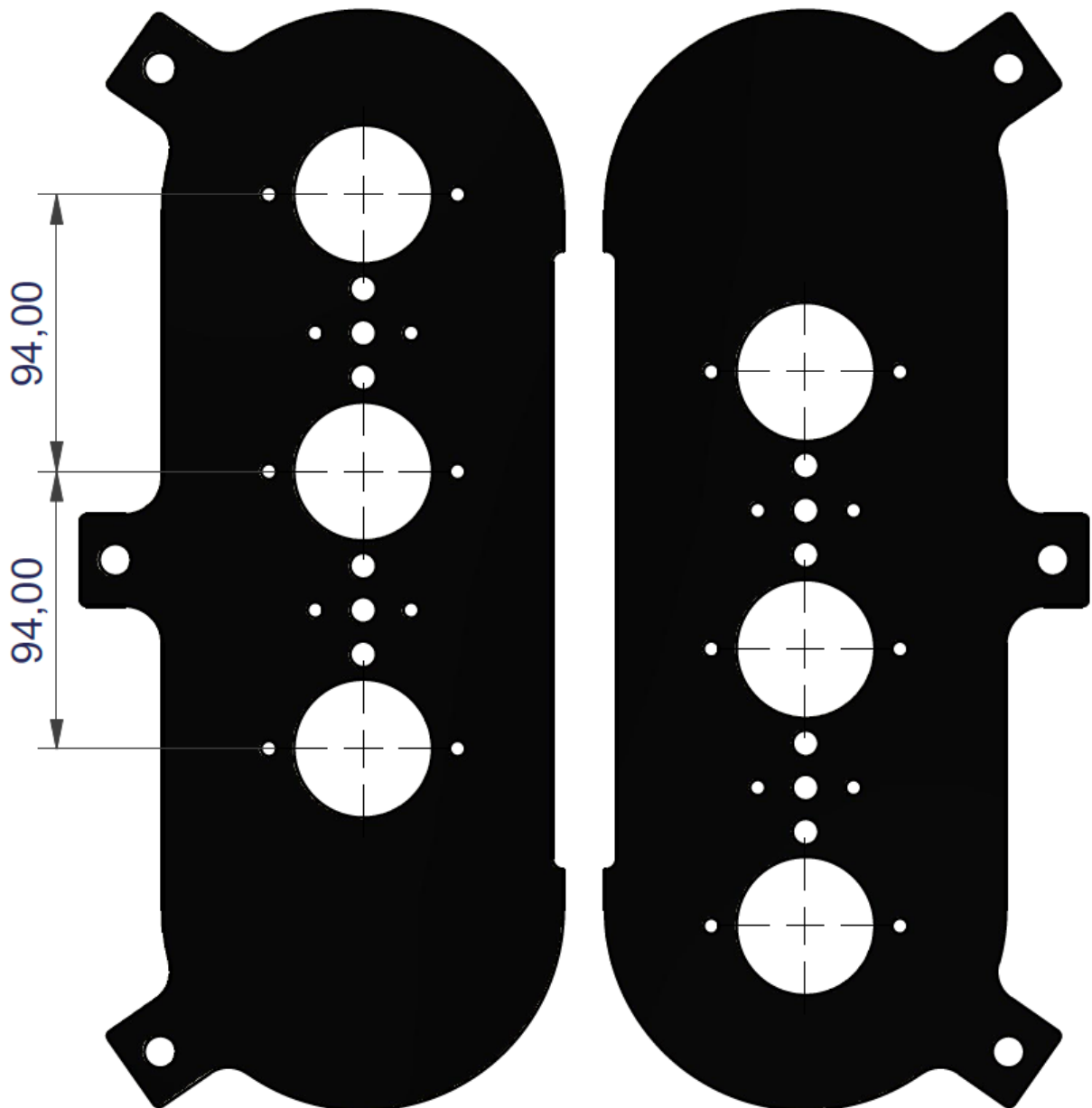

Megaflow Custom Laser Cut Baseplate Profiles

Can't find an off-shelf baseplate to suit your application?

We offer a Laser Cutting service for custom profiles, where an off-shelf solution cannot be found. With the below information from you we can create a direct fit baseplate specific to your vehicle!

How to specify custom ITG Megaflow Baseplates...

For Weber DCOE Carbs, Throttle Bodies or similar, we require the brand/model of the setup. From this information we can determine your port spacings which are in most cases 90mm set by the manufacturer of the inlet.

E.g.- Weber 45 DCOE

Jenvey 48 ITB's

SU-HS6

We then need to know the centre-to-centre distance (**A**) for the main air intakes. This can be measured directly from the centres or if easier, from edge-edge of the main opening's as shown in the diagrams.

JC20 Baseplate

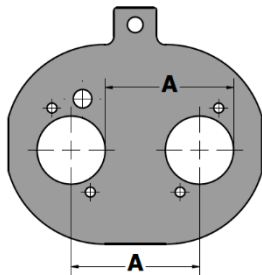

JC30 Baseplate

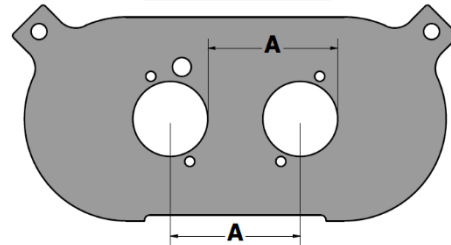

JC40 Baseplate

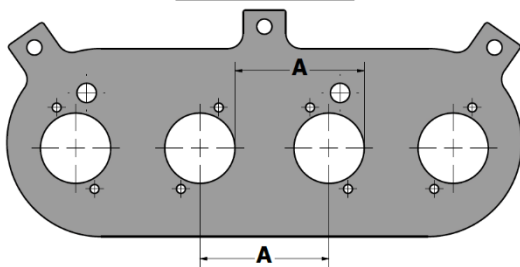

JC50 Baseplate

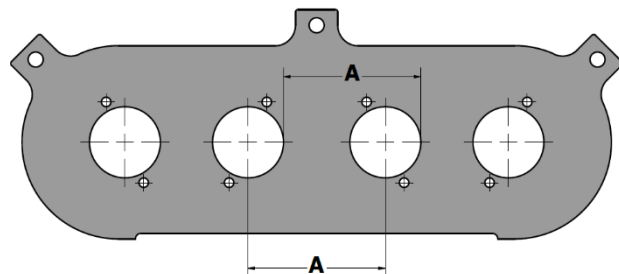

JC55 Baseplate

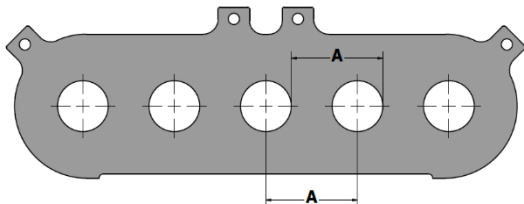

JC100 Baseplate

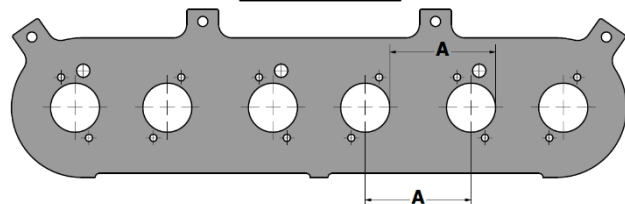

How to specify custom offset Megaflow Baseplates...

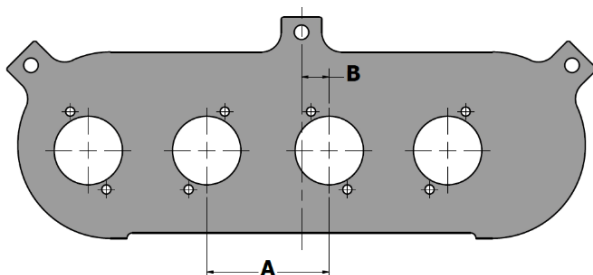

Profiles are normally centralised, however where required we can offset the profile to clear bodywork. We will work with you to find the ideal offset value (RH or LH) to ensure there will be no internal filter clearance issues, such as airhorns touching internal filter support cages (**B**).

Get in touch with our Technical team for a quote today – technical@itgairfilters.com